

PlastiDuct is quick and easy to install

- Screw base into wall with screw anchors using the pre-drilled holes.
- Hold tubing into base with the specially designed colored clips.
- Place PlastiDuct cover and fittings over base and tubing.
- Use additional screws and caulk where necessary. **Job done!**

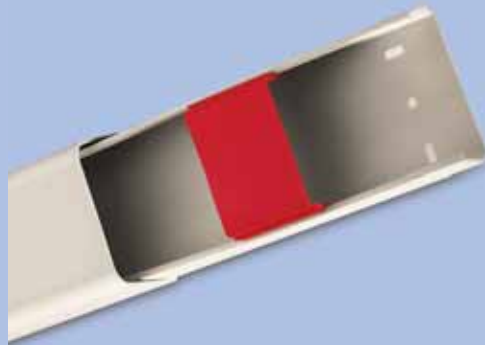
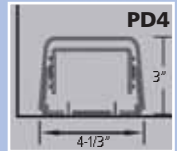
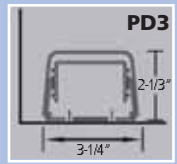

PlastiDuct

Product	Size (inches) W x D x L	Packaging
PD3	3-1/4 x 2-1/3 x 6-1/2	8 pcs / 52-1/2 ft.
PD4	4-1/3 x 3 x 6-1/2	4 pcs / 26-1/3 ft.

Clips

Product	Color	Packaging
PDC3	Red – For use with PD3	30
PDC4	Green – For use with PD4	20

End Cap

Product	Packaging
PDECap3	For use with PD3
	9

Corner Wall Elbow

Product	Packaging
PDWE3	For use with PD3
	6
PDWE4	For use with PD4
	4

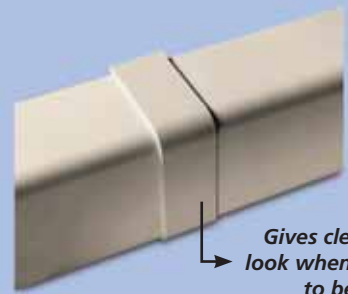

Gives clean professional look when PlastiDuct needs to be connected

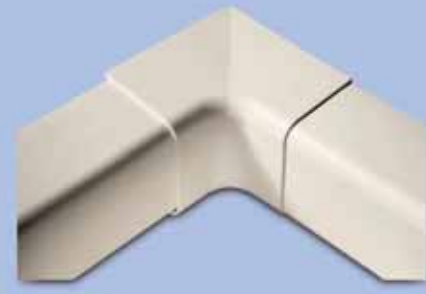

Cover Joints

Product	Packaging
PDCJ3	For use with PD3
	30
PDCJ4	For use with PD4
	20

Internal Corners

Product	Packaging
PDIC3	For use with PD3
	6
PDIC4	For use with PD4
	4

Wall Passage

Product	Packaging
PDWP3	For use with PD3
	8
PDWP4	For use with PD4
	8

"T"

Product	Packaging
PDT3	For use with PD3
	4
PDT4	For use with PD4
	2

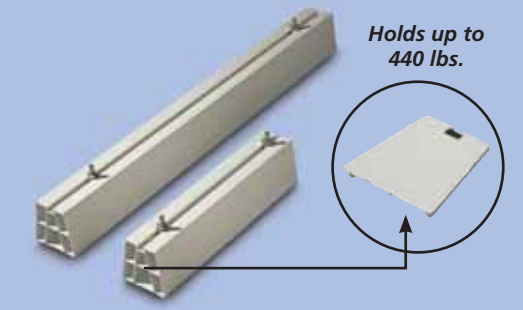

External Corners

Product	Packaging
PDEC3	For use with PD3
	9
PDEC4	For use with PD4
	6

Flat Curve

Product	Packaging
PDFC3	For use with PD3
	8
PDFC4	For use with PD4
	6

Reducers

Product	Packaging
PDR4	For use with PD4
	8

Floor Supports

Product	Size (inches) W x D x L	Packaging
PDF18	18 x 4 x 4	24
PDF39	39 x 4 x 4	4
PDFC	Floor Support Caps	24

PLASTIDUCT

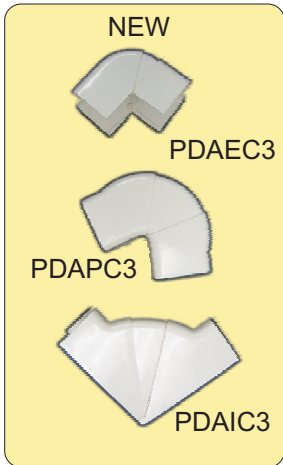
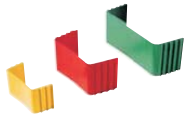

UR Catalog Number	IRP Product Code Number	Description	Weight (lbs)	QTY
PD3	415-0001	CANALSPLIT 08, Code 0812 BC, 2 meter lengths (6.5 Ft), 16 meters per carton (52.5 Ft approx.)	5.00	8pcs
PD4	415-0002	CANALSPLIT 12, Code 1212 BC, 2 meter lengths (6.5 Ft), 8 meters per carton (26.25 Ft approx.)	5.00	4pcs
PDC3	415-0003	Brackets, FAST block, Code 0803 ST (red color), 30 per pack	0.04	30
PDC4	415-0004	Brackets, FAST block, Code 1203 ST (green color), 20 per pack	0.04	20
PDCJ3	415-0005	Cover Joint, Code 0804 GC, 30 per pack	0.04	30
PDCJ4	415-0006	Cover Joint, Code 1204 GC, 20 per pack	0.07	20
PDIC3	415-0007	Internal Corner, Code 0805 AI, 6 per pack	0.18	6
PDIC4	415-0008	Internal Corner, Code 1205 AI, 4 per pack	0.31	4
PDEC3	415-0009	External Corner, Code 0806 AE, 9 per pack	0.16	9
PDEC4	415-0010	External Corner, Code 1206 AE, 6 per pack	0.29	6
PDFC3	415-0011	Plane Curve, Code 0807 CP, 8 per pack	0.20	8
PDFC4	415-0012	Plane Curve, Code 1207 CP, 6 per pack	0.38	6
PDECAP3	415-0013	End Cap, Code 0808 TT, 9 per pack	0.13	9
PDWE3	415-0014	Corner Wall Elbow, Code 0809 CM, 6 per pack	0.29	6
PDWE4	415-0015	Corner Wall Elbow, Code 1209 CM, 4 per pack	0.28	4
PDWP3	415-0016	Wall Passage, Code 0810 PM, 8 per pack	0.38	8
PDWP4	415-0017	Wall Passage, Code 1210 PM, 8 per pack	0.11	8
PDT3	415-0018	"T" Shunt, Code 0813 DT, 4 per pack	0.29	4
PDT4	415-0019	"T" Shunt, Code 1213 DT, 2 per pack	0.11	2
PDR4	415-0020	Reduction, Code 1280 RI, 8 per pack	0.14	8
PDF18	415-0021	Floor Suport, Code 0450 SP, 24 per pack ,color RAL 1013, 45 cm long (18")	0.13	24
PDF39	415-0022	Floor Suport, Code 1000 SP, 4 per pack, color RAL 1013, 1 meter long (39")	0.38	4
PDFC	415-0023	Cap for Floor Support, Code 0341 TS, Color RAL 1013, 24 per pack	0.07	24
PDAIC	415-0024	Adjustable Corner, 80°- 105°, 6 pcs per pack	0.28	4
PDAEC3	415-0025	Adjustable External Corner, 70°- 120°, 6 pcs per pack	0.13	6
PDAPC3	415-0026	Adjustable Plane Curve, 65°- 130°, 6 pcs per pack	0.13	6

Plastiduct is an Attractive and Stylish Solution for Hiding Tubing and Pipe.
 *High Quality PVC
 *Quick & Easy Installation
 *UV & Shock Resistant
 *Paintable PVC to Match Surroundings
 *Non-flammable
 *UL94 Temperature Acceptability -4 to 140