



## INTERNATIONAL REFRIGERATION PRODUCTS CO., INC. LIMITED WARRANTY POLICY

International Refrigeration Products Co., Inc. (Hereinafter referred to as "IRP") warrants the following:

Only cataloged products sold to distributors are warranted to the original purchaser, to conform with specifications furnished or approved by IRP, and to be free from defects in material and workmanship, for a period of one (1) year from the date of purchase, unless specified in writing for a different period. Prior to returning this product to IRP, the purchaser shall give IRP notice in writing stating how this product fails to fulfill this warranty. No product shall be accepted for repair or replacement without a required written notice and without prior written authorization and shipping address having been received by the purchaser from IRP. Only IRP's factory is authorized to perform services under this warranty. Transportation charges are to be prepaid by the purchaser.

This warranty does not extend to any product that has been subjected to misuse, abuse, neglect, accidents, alternations, improper installation or use in violation of the printed instructions furnished by IRP. This warranty neither applies to batteries not deterioration of, nor damage to the product caused by the use of faulty batteries. Final determination as to whether any product is actually defective rests solely with IRP.

This warranty is expressly in lieu of all other agreements and warranties, expressed, implied, or statutory and IRP has no other obligations or liabilities in connection with this product. In no event shall IRP's obligation or liability hereunder exceed the purchase price of this product. **IRP SHALL NOT IN ANY EVENT BE LIABLE FOR ANY INCIDENTAL OR CONSEQUENTIAL DAMAGES.**

This warranty gives you specific legal rights, and you also have other rights which vary from state to state. Some states do not allow the exclusion or limitation of incidental or consequential damages, or implied warranties, so the above limitations or exclusion may not apply to you.

**INTERNATIONAL REFRIGERATION PRODUCTS CO., INC.**  
**Toms River, N.J. 08755**

**Customer Service**  
**Phone: 704-504-8590 Fax: 704-504-3023**  
[www.irproducts.biz](http://www.irproducts.biz)

### TSN11X SINGLE STAGE THERMOSTAT

1 Heat / 1 Cool single stage thermostat.  
Non Programmable, Compatible with heat pump system

#### Installation and Operation Manual

#### Specification:-----

Power Supply: 20VAC-30VAC 50-60HZ or Battery powered.  
Terminal Load: 1.0A per terminal, 3.0A maximum total load  
Set Point Temp. Range: 45°F to 90°F (7°C to 32°C).  
Accuracy: +/- 1°F or +/- 0.5°C.  
Dimensions: 5.1" W X 3.7" H X 1.2" D  
Color: White

#### FEATURES:-----

- Large LCD display with backlight, continuous backlight option.
- Simultaneous heat and cool set point storage.
- Display of room temperature, set temperature and current time simultaneously.
- Fan switch with ON and AUTO functions.
- Permanent user setting retention during power loss. No batteries are required.\*
- Operates from 24VAC, or from 2 size "AAA" alkaline batteries.
- Air Filter change Indicator.
- Low Battery Indicator.
- Temperature calibration.
- Batteries required to maintain clock function.

#### IMPORTANT SAFETY INFORMATION-----

- Always turn off power at the main power source by removing the fuse, or switching the circuit breaker to the off position before installing, removing, cleaning, or servicing this thermostat.
- Read all of the information in this manual before installing this thermostat.
- Use a professional contractor to install this thermostat.
- This is a 24VAC low-voltage thermostat. **DO NOT INSTALL ON VOLTAGES HIGHER THAN 30 VAC.**
- **ALL** wiring must conform to local and national building and electrical codes and ordinances.
- Do not short (jumper) across terminals on the gas valve or at the system control to test installation. This will damage the thermostat and void the warranty.
- Do not switch the system to cool if the temperature is below 50°F (10°C). This may damage the air conditioning system.
- Replace batteries when the battery icon indicates the low battery message.
- Change the Air Filter when the Filter Change Icon begins blinking.
- Use this thermostat only as described in this manual.

**REMOVE THE OLD THERMOSTAT**-----

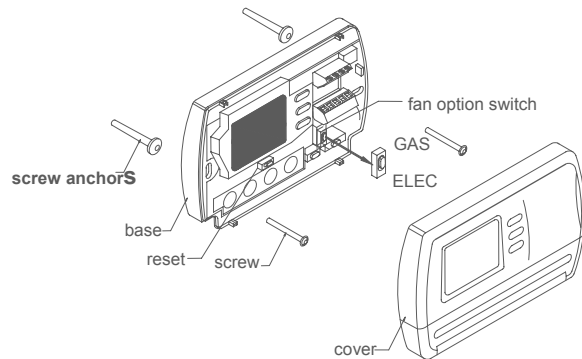
**WARNING! Electrical Shock Hazard**

1. Turn off power at the main service panel by removing the fuse or switching the appropriate circuit breaker to the OFF position before removing the existing thermostat.
2. Turn off power to the heating and cooling system by removing the fuse or switching the appropriate circuit breaker off.
3. Remove the cover of the old thermostat. This should expose the wires.
4. Label the existing wires from the existing thermostat before removing.
5. After labeling the wires, remove the wires from the wire terminals.
6. Remove the existing thermostat from the wall.
7. Refer to the following section for instructions on how to install this thermostat.

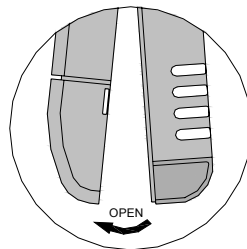
**INSTALL THE THERMOSTAT**-----

**ATTACH THERMOSTAT BASE TO WALL**

**PULL THE COVER OFF THE BASE.**

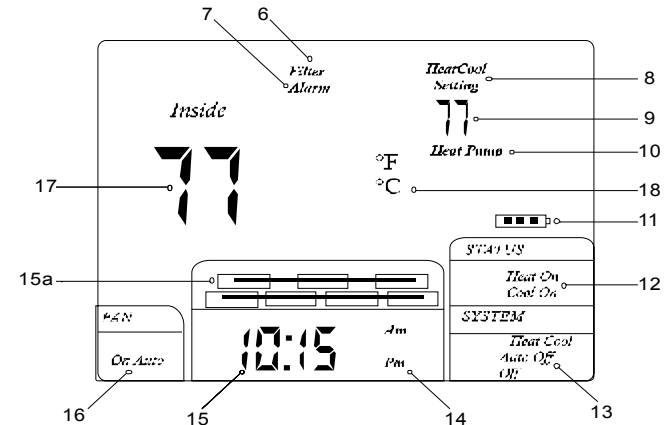


**Figure 1**



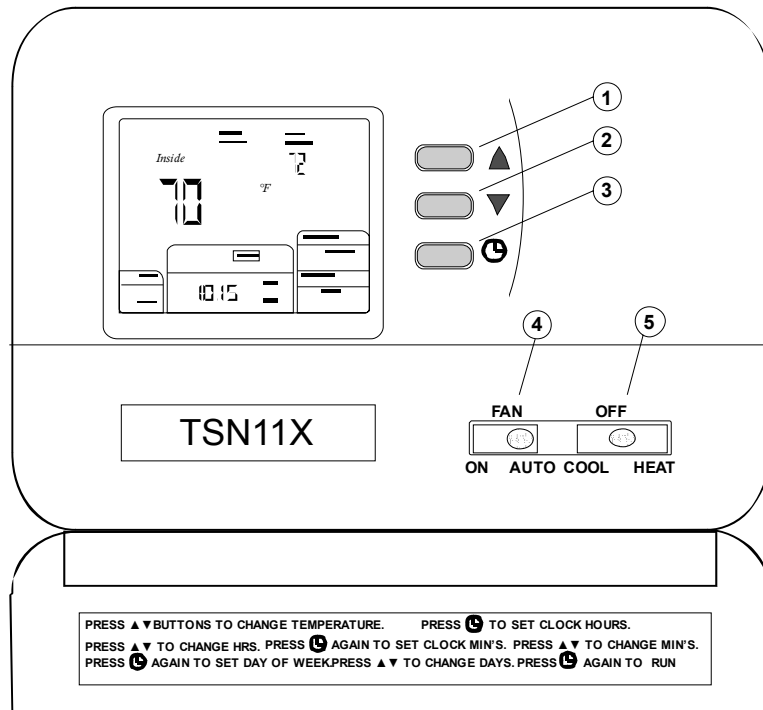
**Figure 2**

**THERMOSTAT LCD DISPLAY**



- (6) Filter Alarm: Indicates filter needs to be replaced.
- (7) Alarm (This option available in Heat Pump models).
- (8) Heat/Cool Setting: Indicates whether the current set-point temperature is for Heating or Cooling.
- (9) Displays the current Set-point temperature.
- (10) Indicates the thermostat is calling for heat in the heat pump mode.
- (11) Battery Icon: If the battery icon is blinking, it indicates the batteries need to be replaced.
- (12) Indicates the thermostat is calling for Heating or Cooling.
- (13) Indicates the current System switch position.
- (14) Indicates whether the time is AM or PM
- (15) Indicates the current time.
- (15a) Indicates current day of the week.
- (16) Indicates the current Fan switch position.
- (17) Indicates the current room temperature. In the configuration mode, it indicates the current configuration menu item.
- (18) Indicates whether the temperature display is in °F or °C.

## Thermostat Buttons and Switches



- (1) and (2) Raises or lowers the temperature setting and selects options in the configuration menu.
- (3) Selects clock set mode, Indicates filter time remaining, and selects menu items in the configuration menu.
- (4) Fan control switch (**Auto/On**)
- (5) System control switch (**COOL/OFF/HEAT**)

## **WARNING!** Electrical Shock Hazard

Turn off power at the main service panel by removing the fuse or switching the appropriate circuit breaker to the OFF position before removing the existing thermostat.

1. Turn off power to the heating and cooling system by removing the fuse or switching the appropriate circuit breaker off.
2. Place the system switch (**COOL/OFF/HEAT**) in the **OFF** position.
3. Place the **FAN (AUTO/ON)** switch in the **AUTO** position.
4. Gently pull the cover straight off the base. (See figure 2.)
5. Put the thermostat base against the wall where you plan to mount it. (Be sure the wires will feed through the wire opening in the base of the thermostat.)
6. Mark the placement of the mounting holes.
7. Move the base out of the way. Drill mounting holes. Use a hammer to tap in the supplied anchors into the mounting holes.
8. Fasten the base loosely to the wall as shown in Figure 1, using two mounting screws. Place a level against the bottom of the base and adjust until level, then tighten the screws. (Leveling is for appearance only, and will not affect thermostat operation.)
9. Insert stripped, labeled wires into matching wire terminals. See "Wiring Diagrams", Section 3, Figure 3.

**CAUTION:** Be sure exposed portions of wires do not touch other wires.

10. Tighten screws on terminal block. Gently tug on each wire to be sure of proper connection. Double check that each wire is connected to the proper terminal.

**CAUTION:** Installing batteries backwards can damage the thermostat.

11. Install two fresh "AAA" alkaline batteries in the battery compartment. Be sure to match positive (+) ends of batteries with positive (+) battery terminals in the battery compartment. (The thermostat will operate from 2 size "AAA" alkaline batteries or 24VAC power. When operated from 24VAC power, your thermostat will maintain time and continuously display the temperature during a loss of AC power with the batteries installed).
12. Replace the cover on the thermostat by snapping it in place.
13. Turn on power to the system at the main service panel.
14. Test thermostat operation as described in the following section.

## FAN OPTION SWITCH

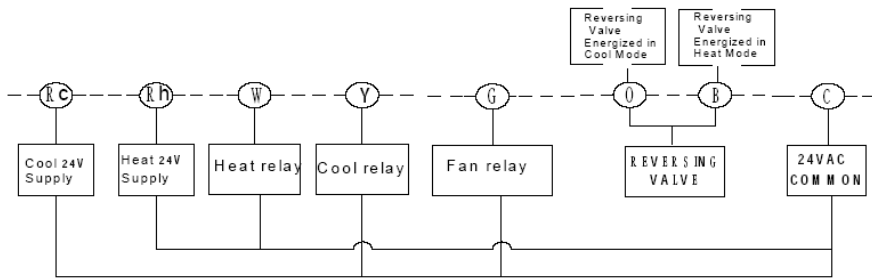
Read the following information before setting the fan option switch (See figure 1). If you are unsure of your application, contact a qualified service person.

This thermostat is configured from the factory to energize the fan on a call for heat. If your system is an electric heat or heat pump that **REQUIRES** the thermostat to turn on the fan on a call for heat, place the fan option switch in the **ELEC** position. If your system does not require the thermostat to energize the fan on a call for heat such as fossil fuel (gas, oil, etc.), forced air system as well as hydraulic heating systems, place the fan option switch in the **GAS** position.

## BATTERY OPERATION

The thermostat will operate from 2 size "AAA" alkaline batteries or 24VAC power. When operated from batteries, connection to the "C" (common) or (neutral) terminal is not required. **NOTE:** When operated from batteries only, the LCD display backlight will be lighted less than 5 seconds after each button pressed, when backlight option are set to 2) or 3).

## Wiring Diagrams




**Figure 3, Typical wiring diagram for heat/cool, 5 wire two transformer system.**


## THERMOSTAT OPERATION


### 1. Setting the thermostat


This thermostat is very easy to operate. Set the **SYSTEM** switch to either **HEAT** or **COOL**, then press the **▲** or **▼** buttons until the temperature you want to maintain is shown on the right side of the display. If you want to turn the system off, just move the **SYSTEM** switch to the **OFF** position and the **FAN** switch to the **AUTO** position.

### 2. Set current day and time

Move the system switch to **COOL** or **HEAT**. Press the  button momentarily. The hours display will begin to blink. Press the **▲** or **▼** buttons until you reach the correct hour and AM/PM designation. (AM begins at mid-night, and PM begins at noon).


Press the  button again. The minutes display will begin to blink. Press the **▲** or **▼** buttons until you reach the correct minutes.


Press the  button again. The day of the week will begin to blink. Press the **▲** or **▼** buttons until you reach the correct day of the week.

Press the  button again. The display will now indicate the correct time and day of the week.

### 3. Filter timer

a) When in configuration the selections are in months, each month selections are equal to 30 days.

b) To review the remaining days hold the  button for 3 second

c) To reset the filter days - hold the  button for 3 second (to enter the filter program) and then hold the **▲** and **▼** buttons. This resets the timer and starts counting the days until the next filter change.

### Troubleshooting-----

If a voltage spike or static discharge blanks out the display or causes erratic thermostat operation, you can reset the thermostat by pressing the reset button (See Figure 1). If the thermostat has power, and has been reset and still does not function correctly, contact your heating/cooling service contractor

1. **Select cooling cycle rate**

The **FA** setting is used to produce shorter cooling cycles. The **SL** setting produces a longer cooling cycle. Both settings produce very accurate temperature control and can be set to your personal preference. **FA** cycles the system at a 0.5°F (0.5°C) differential, and **SL** cycles the system at 1.5°F (1.5°C).

2. **Select heating cycle rate**

The **FA** setting is used to produce shorter heating cycles. The **SL** setting produces a longer heating cycle. Both settings produce very accurate temperature control and can be set to your personal preference. **FA** cycles the system at a 0.5°F (0.5°C) differential, and **SL** cycles the system at 1.5°F (1.5°C).

3. **Select system heating type**

Users can select the system heating type according to their heating system. Select **0** for gas, oil, or electric heating systems. Select **1** for a heat pump heating system.

4. **Select display backlight**

The display backlight improves display contrast in low lighting conditions. Select **1** for NO backlight display. Select **2** for the backlight to come on for approximately 30 seconds when any button of the thermostat is touched. Select **3** for the backlight to remain on continuously.

**NOTE:** When operated from batteries only, the LCD display backlight will be illuminated less than 5 seconds after each button pressed, when backlight option are set to 2) or 3). Options 2) & 3) will operate the same when terminal "C" is not connected.

5. **Select filter replacement run time**

The thermostat will display the **Filter Alarm** after a set time of operation. This is a reminder to change or clean your air filter. This time can be set from 0 to 12 months in 1 month increments. Selection of **00** WILL CANCEL THIS FEATURE. When **Filter Alarm** is displayed, you can clear it by pressing the **⌚** button for 3 seconds (To enter filter program) and then hold the **▲** and **▼** buttons. This resets the timer and starts counting the days until the next filter change.

6. **Select °F or °C readout**

Changes the display readout to Centigrade or Fahrenheit as required.

7. **Select temperature recalibration**

This feature allows you to adjust the displayed room temperature up to 4° higher or lower. Your thermostat can be accurately calibrated to match your previous thermostat. The current or adjusted room temperature will be displayed on the display.

8. **Select compressor lockout delay**

To protect the compressor from short cycling, you can select compressor off-time cycle between **0** or **5** minutes. When the thermostat compressor time delay occurs, the **Cool On** or **Heat On** display will flash during compressor lockout.

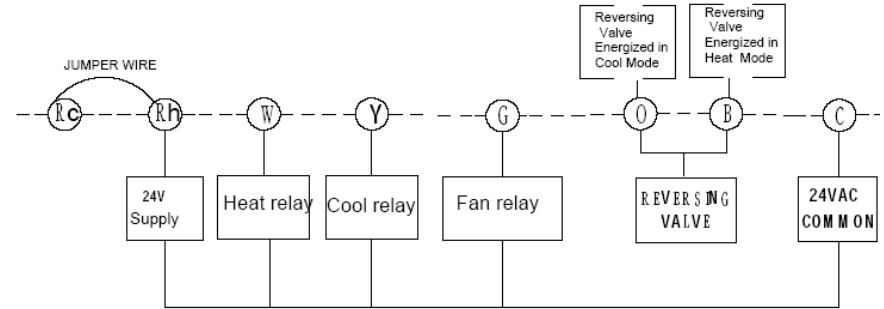
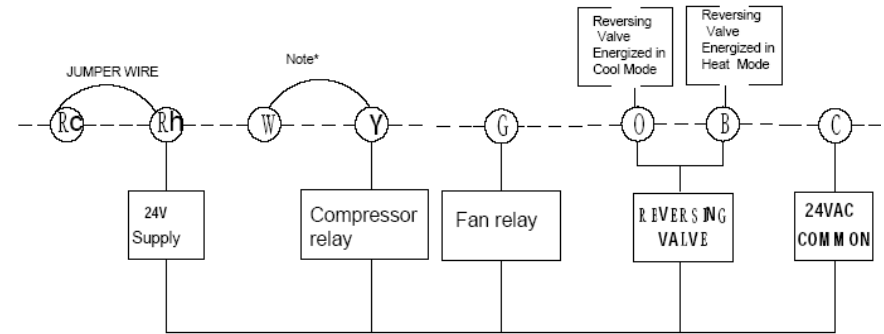


Figure 4, Typical wiring diagram for heat/cool, 4 wire, single transformer system



Note\* Jumper required in heat pump mode.

Figure 5, Typical wiring diagram for heat pump with reversing valve

**CHECK THERMOSTAT OPERATION**-----

If at any time during testing your system does not operate properly, contact a qualified service person.

Turn on power to the system.

**Fan Operation**

Move the system switch to the **OFF** position. If your system does not have a "G" (Fan) terminal connection, skip to the Heating System.

1. Move the fan switch to the **ON** position. The blower should begin to operate.
2. Move the fan switch to the **AUTO** position. The blower should stop immediately.

**Heating System**

1. Move the **SYSTEM** switch to the **HEAT** position. If the auxiliary heating system has a standing pilot, be sure to light it.
2. When the (FA)st heating cycle rate is selected in the configuration menu, (see configuration menu item 2), the thermostat will call for heat at 0.5°F (0.5°C) below set-point, and turn off at set point. When the (SL)ow heating cycle rate is selected, the thermostat will call for heat at 1.5°F (1.5°C) below set-point, and turn off at set-point. When the thermostat calls for heat, the display will show **Heat On**. If the **Heat On** display is flashing, the compressor lockout feature is operating in the heat pump mode. (Note: See Configuration menu item 8).

### Cooling System

**CAUTION:** To prevent compressor and/or property damage, if the outdoor temperature is below 50°F (10°C), **DO NOT** operate the cooling system.

1. Move the **SYSTEM** switch to the **COOL** position.
2. When the (FA)st cooling cycle rate is selected in the configuration menu, (see configuration menu item 2), the thermostat will call for cooling at 0.5°F (0.5°C) above set-point, and turn off at set point. When the (SL)ow cool cycle rate is selected, the thermostat will call for cooling at 1.5°F (1.5°C) above set-point, and turn off at set-point. When the thermostat calls for cooling, the display will show **COOL On**. If the **COOL On** display is flashing, the compressor lockout feature is operating. (Note: See Configuration menu item 8).

If all functions operate properly, the thermostat is installed correctly.

### Replacing Batteries

If your thermostat was pre-installed, the batteries may be in place. If the battery icon on the display is flashing, it indicates that the batteries need to be replaced. When the thermostat is powered only by battery, the battery icon will flash for approximately 2 months before the batteries are expected to expire. Then the thermostat will cut power to the heating/cooling system.

**Important:** Replace the batteries when the low battery message flashes on the display. This will keep the thermostat operating properly. With two “AAA” batteries installed, your thermostat will maintain time and continuously display the temperature during a loss of AC power.

1. Place the **COOL/OFF/HEAT** switch in the **OFF** position.
2. Put the **FAN AUTO/ON** switch in the **AUTO** position.
3. Gently pull the cover straight off the base.
4. Install two “AAA” alkaline batteries in the battery compartment. Be sure to match the positive (+) ends of the batteries with the positive terminals marked in the battery compartment.


5. It may take as long as 30 seconds of operation for the Low Battery icon to disappear after changing batteries.

**CAUTION:** Incorrect battery installation can damage the thermostat and void the warranty.








## CONFIGURATION AND OPERATION

### Configuration Menu

The configuration menu allows you to set certain thermostat operating characteristics to your system or personal requirements. Move the **SYSTEM** switch to the **OFF** position, then press and hold the ▲ and ▼ buttons for 5 seconds to enter the configuration menu. The display will show the first item in the

configuration menu. Press the  button to shift to the next menu item. Use the ▲ and ▼ buttons to select. To exit the configuration menu and return to normal operation, move the **SYSTEM** switch to the **HEAT** or **COOL** position. If no buttons are pressed within 1 minute, the thermostat will exit the configuration menu.

The configuration menu chart summarizes the configuration options. An explanation of each option follows.

Step	Press Buttons	Displayed (Factory Defaults)	Press ▲ or ▼ to select	Description
1	▲▼5 seconds	CC (FA)	FA or SL	Cooling Cycle Rate; Select (FA)st or (SL)ow. Default = (FA)
2		HC (FA)	FA or SL	Heating Cycle Rate; Select (FA)st or (SL)ow. Default = (FA)
3		h0 (0)	0 or 1	Select system heating type. 0 = Gas, oil or electric 1 = heat pump. Default = 0
4		bL (2)	1 – 3	Select display backlight (1) = OFF, (2) = 30 seconds on any button push, (3) = ON. Default = 2. <b>Option (3) can be activated only if the common is used.</b>
5		FL (00)	00 – 12	Select Filter Time in one month increments from 00 to 12 months. Default = 00. A selection of “00” deactivates the filter feature.
6		FC (F)	F or C	Select Temperature display to °F or °C. Default = F
7		CL (0)	+4 TO -4	Select temperature calibration point up to 4° higher or 4° lower. Default = 0
8		CP (5)	0 or 5	Select compressor delay time. 0 = no delay, 5 = 5 minute delay. Default = 5
9	Move <b>SYSTEM</b> switch to <b>HEAT</b> or <b>COOL</b> to resume normal operation			